

版本 REV.	日期 DATE	ECN NO.	变更内容 DESCRIPTION	制图 DRAWN

SPECIFICATIONS

- 1、Current Rating: 1A AC, DC
- 2、Voltage Rating: 200V AC, DC
- 3、Temperatuer Range: -25°C~+85°C
- 4、Contact Resistance: 20mΩ Max
- 5、Insulation Resistance: 1000MΩ Min
- 6、Withstanding Voltang: 1000V AC/minute
- 7、Material: Wafer LCP, UL94V-0  
PIN Phosphoric bronzes Tin-plated  
Solder tad Brass Tin-plated

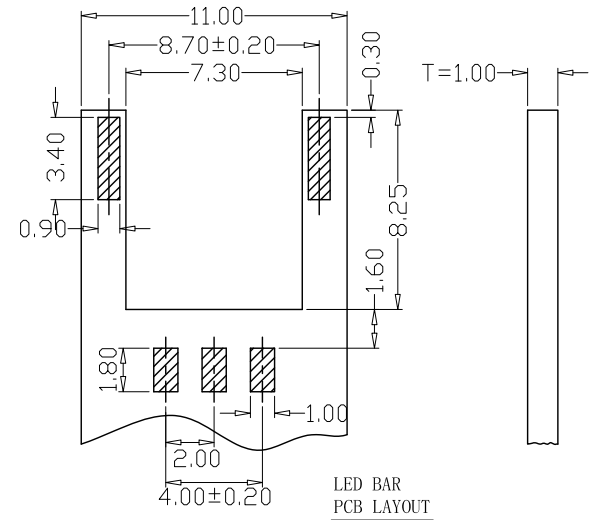
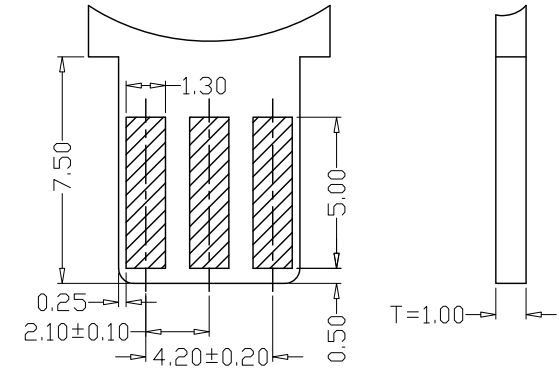
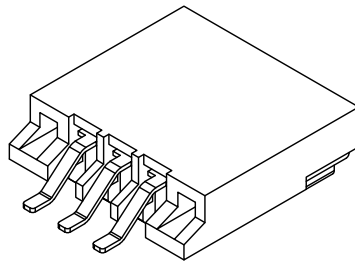
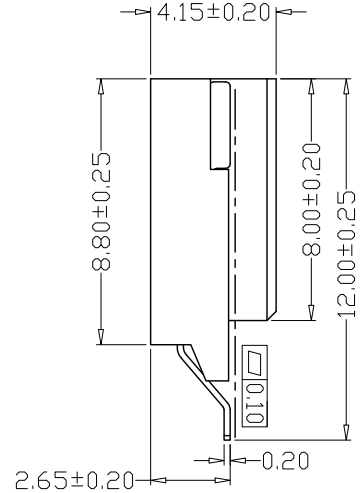
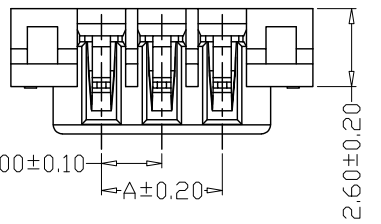
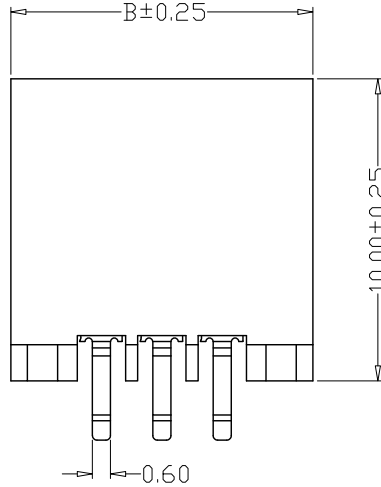
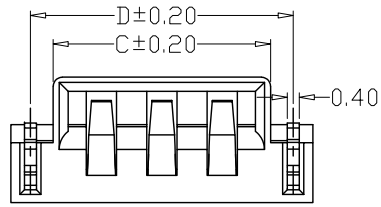

PIN	尺寸 (mm)			
	A	B	C	D
-02AWB	2.00	8.00	5.20	6.70
-03AWB	4.00	10.00	7.20	8.70
-04AWB	6.00	12.00	9.20	10.70

GENERAL TOLERANCE		制图 Mapping	张迎春 2022、09、12		料号 PART NO.	B20006-nAWB		版本 REV.	A
X±0.25	X°±2°	审核 Audit	钱岳生 2022、09、12		品名 TITLE	20035沉板式卧贴 WAFER SMT TYPE		页次 SHEET	1/1
.X±0.25	.X°±1°	核准 Approved	张名 2022、09、13		客户料号 CUTM. NO.				
.XX±0.15	.XX°±0.5°	单位 Units	MM	比例 SCALE	1:1	<b>乐清市宏一电子有限公司</b> YueQing HongYi Electronics Co., Ltd			
.XXX±0.10	.XXX°±0.5°								